

XMAXXX-1822

American Bass
"Excellence In Sound"

OWNER'S MANUAL

XMAXXX-18" 2Ω SUBWOOFER

4000W RMS



"Excellence In Sound"

CONTENTS

1. INTRODUCTION
2. SAFETY INSTRUCTIONS
3. SPECIFICATIONS
4. THIELE-SMALL PARAMETERS
5. PRODUCT DIMENSIONS
6. PORTED BOX FOR SINGLE 18 INCH SUBWOOFER
7. PORTED BOX FOR DOUBLE 18 INCH SUBWOOFER

INTRODUCTION

Thank you for purchasing your American Bass product. We take pride in delivering powerful high-performance sound systems engineered for exceptional volume and clarity—without compromising quality.

To get the most out of your product, please read this manual carefully before installation and use. It's especially important to review all safety precautions and setup guidelines. Be sure to keep this manual in a safe and accessible place for future reference.

SAFETY INSTRUCTIONS

- **Secure Installation**

Mount the subwoofer securely. A loose subwoofer can become a serious hazard if it shifts or disconnects while driving.

- **Handle with Care**

If possible, keep the subwoofer in its original packaging until installation to prevent accidental damage.

- **Avoid Dropping**

Be cautious when handling the subwoofer. Dropping it can damage internal components.

- **Tool Safety**

Always follow proper safety procedures and wear protective gear when using tools.

- **Power Off Devices**

Turn off the head unit and all connected audio equipment before installation to prevent damage.

- **Check Placement**

Make sure the subwoofer does not obstruct or interfere with any mechanical or electrical components in the vehicle.

- **Avoid Harsh Environments**

Do not install the subwoofer in areas exposed to moisture, extreme temperatures, or dust.

Operating temperature range: +5°C (41°F) to +40°C (104°F)

If condensation occurs, allow the unit to dry completely before use.

SPECIFICATIONS

POWER HANDLING

RMS Power (W)	4000	The continuous power a speaker or subwoofer can handle over time without damage. This is the most important number for matching amplifiers.
MAX Power (W)	8000	The maximum power the unit can handle in short bursts. Not intended for sustained output.
Sensitivity @1w/1m (dB)	87.2	How loud the subwoofer plays with 1 watt of power measured at 1 meter away. Higher numbers mean greater loudness with less power.

PERFORMANCE & SOUND CHARACTERISTICS

Fo (Hz)	32.5	Also called Fs or resonant frequency – the natural frequency at which the subwoofer’s cone moves most freely. Lower values mean deeper bass performance.
Frequency Range	N/A	The range of frequencies the subwoofer can effectively reproduce. Wider ranges mean more flexibility and detail in sound reproduction.

DESIGN & MECHANICAL

Size (Inch)	18	The physical diameter of the driver (e.g., 6.5", 8", 10", 12", 15", 18"). Larger sizes generally offer deeper bass, smaller sizes more precise response.
Voice Coil Size (Inch)	4	The diameter of the voice coil, which affects heat handling and power capacity. Larger coils often mean better performance at high volumes.
Voice Coil Wire	Hi-temp 4-layer voice coil wire	The type of wire used in the coil, impacting heat resistance and durability. EISV and other high-temp wires improve reliability under stress.
Surround Material	Over-sized fat foam surround	The flexible ring around the cone. Rubber is durable and good for high excursion; foam may offer smoother response but shorter lifespan.
Cone	Carbon fiber enforced non-pressed paper cone	The materials used in the cone assembly. "Rubber edge" refers to the surround, and "paper cone" refers to the diaphragm. This combination balances durability with warm sound characteristics.
Cone Material	Carbon-fiber reinforced non-pressed paper	The material used for the cone affects sound signature. Paper is warm and natural, while polypropylene is durable and weather-resistant.
Frame Material	Blue powder-coated heavy-duty basket (metal frame)	The outer structure holding the motor and cone. Aluminum is light and rigid; steel is strong and cost-effective.

MOTOR & MAGNET ASSEMBLY

Magnet Type	Triple-stacked high-energy magnets	The motor’s magnet affects output strength and weight. Ferrite is traditional and strong; neodymium is lighter with high efficiency.
Magnet Weight	N/A	The magnet’s weight, typically in ounces or grams. Heavier magnets usually offer stronger motor force, which can improve bass output and control.

THIELE-SMALL PARAMETERS

POWER & SENSITIVITY

SPL (dB)	87.2	Sensitivity rating. Tells you how loud the sub plays with 1 watt of power. Higher is louder with less power.
Re (Ohm)	N/A	DC resistance of the voice coil – typically a bit lower than the nominal impedance. Helps with amplifier matching.

CONE MOVEMENT & CONTROL

Xmax (mm)	22.5	Maximum cone excursion. How far the cone can move in one direction without distortion. More movement = deeper bass.
Qes	0.47	Electrical damping. Lower = tighter control from your amplifier.
Qms	6.17	Mechanical damping. Higher Qms = better mechanical control of cone movement.
BL	38.12	Magnetic strength of the motor. Higher = tighter, more controlled bass. Think of it as "torque" for your sub.
Mms (g)	929	Mass of the moving parts (cone, coil, suspension). Impacts how fast the cone can move. Lighter = more responsive; heavier = deeper bass.

RESONANCE & BOX DESIGN

Fs (Hz)	32.5	Resonant frequency of the driver. Lower Fs = better for low bass. Ideal for deep subwoofer performance.
Vas (L)	46.98	Volume of air that has the same compliance as the sub's suspension. Used in box design. Lower Vas = smaller box needed.
Sd (cm ²)	N/A	Surface area of the cone. Bigger cone = more air moved = more bass.
Qts	0.43	Total Q factor (electrical + mechanical). Helps determine the best box type. <0.5 = sealed; 0.5–1.0 = ported; >1 = large sealed or specialty boxes.

ELECTRONICS & INDUCTANCE

Le (mH)	N/A	Voice coil inductance. Affects how the sub behaves at higher frequencies. Lower Le = cleaner mids.
Impedance (Ohm)	2+2	Shows the electrical resistance of the subwoofer's voice coils. "4+4 Ohm" means dual voice coils that can be wired for flexibility (e.g. 2Ω or 8Ω total load).

XMAXXX-1822

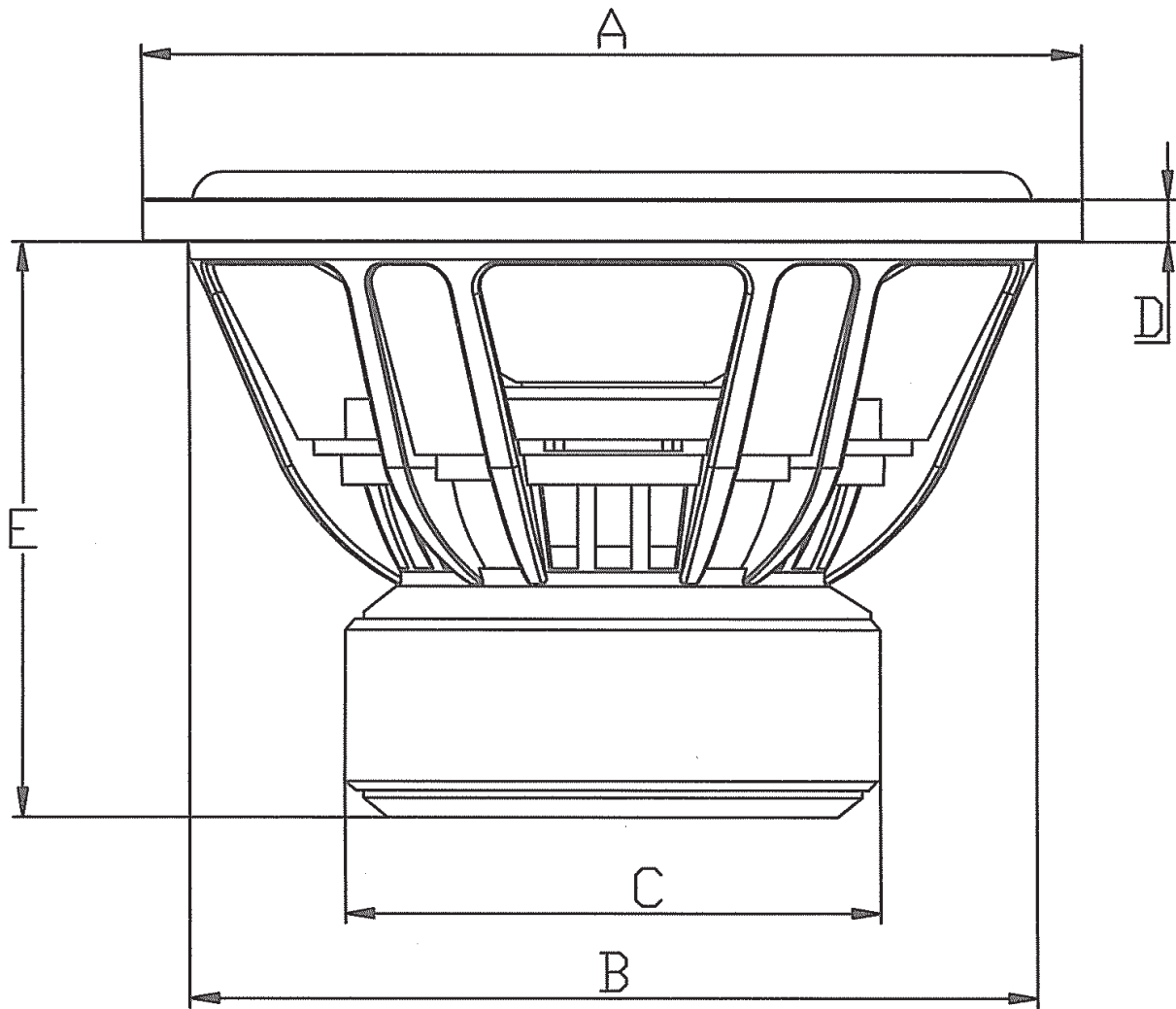

PRODUCT DIMENSIONS

Mounting Depth (inch)	11.5
Mounting Diameter (inch)	16.8
Sealed Box Volume (cubic feet)	N/A

XMAXXX-1822

PORTED BOX FOR SINGLE 18 INCH SUBWOOFER

XMAXXX-1822

PORTED BOX FOR DOUBLE 18 INCH SUBWOOFER

American Bass

“Excellence In Sound”

For More Information Please Visit

www.AmericanBassUSA.com



SCAN TO LEARN MORE



WARNING!

- These subs hit hard — please listen responsibly.
- Extended exposure to loud bass can cause hearing damage.
- Use caution when adjusting volume.
- American Bass is not liable for shattered glass, hearing loss, or related damage.
- Our subs are built for power. Use with care.